

YIH



SHIN

SINCE 1975



TAIWAN

**INDUSTRIAL SEWING MACHINE
PARTS & PRESSER FOOT**

MANUFACTURING & WHOLESALING

YIH SHIN



SINCE 1975



土耳其商標
Turkey Trademark



歐盟商標
European Community Trademark



台灣註冊商標
Taiwan Trademark



台灣出口商標
Taiwan Export Trademark



YIH SHIN



SINCE 1975

Company Profile

YIH SHIN COMPANY was founded in 1975.

We are high quality presser feet manufacturer for industrial sewing machines.

Major Products : Presser feet

Quality Policy :

- Precision
- Durable
- Creation

Core Value:

- Y : Yielding
- I : Innovation
- H : Hearten
- S : Satisfactory
- H : Healthful
- I : Integrity
- N : Normalization

YIH SHIN Brand :

- We have an excellent YIH SHIN brand reputation through 40 years of business experience.
- Trademark Registration : European Community 、 Turkey 、 Taiwan
Remark : Other countries are in processing.

Our Product :

- All our items made in Taiwan by ourselves.
- After complete payment, we lead time in two days to finish export.
- We have efficient production technique to launch new products regularly.
- We accept custom produce order.
- Our market sells to the world.



YIH SHIN



SINCE 1975

公司簡介

邑新針車企業有限公司創立於 1975 年。
我們是高品質工業用縫紉機押布腳製造商。

主要產品：押布腳

品質政策：

- 精密
- 耐用
- 創新

核心價值：

- Y: 靈活
- I: 創新
- H: 激勵
- S: 滿意
- H: 健康
- I: 廉正
- N: 標準

YIH SHIN 品牌：

- 我們具有 40 年良好信用商譽的銷售經驗。
- 商標註冊：歐盟、土耳其、台灣。
- 註：其他國家正在申請中。

產品說明：

- 產品皆在台灣製造生產。
- 充足的庫存量與快速出貨服務。
- 卓越的生產技術並定期發表新產品。
- 接受客製化生產訂單。
- 產品行銷於全世界。





**Chairman Of The Board
Ming Tong Liu**

YIH SHIN



YIH SHIN was founded in 1975. For over 40 years we have consistently adhered to developing the highest quality in industrial sewing machine presser feet to best suit our client's needs and expectations.

From producing to export, we are a complete service provider. "Quality first" has always dictated our production and is what led us to becoming the number one manufacturer of industrial sewing machine presser feet. We can get ahead of the competition, because keep introducing innovative product in the market. Good reputation has always been our strength.

YIH SHIN's leading edge technology, modern precision machinery, and automated pipeline have allowed for unrivalled accuracy, speed and build quality.

We major export in Europe, Asia, North America, South America and Oceania. After complete payment, we lead time in two days to finish export.

Your order is of the utmost importance to us and we truly aspire to fulfil each and every expectation. If you have any queries or require technical advice, please do not hesitate to contact our friendly staff.

邑新公司創立於西元 1975 年，40 多年來始終如一，堅持提供高品質、高附加價值的工業用縫紉機零件 - 押布腳產品。我們從事專業押布腳製造、開發、客製及行銷等為主要營業項目，持續至今一直以生產「品質第一」的押布腳為目標。

我們堅守著高精準度的品質承諾，且因應著市場上的需求及時代的進步，更積極購置先進自動化機械，使生產線更加專業與高效率。

我們有完善的庫存管理，可以隨時配合客戶需求，提供快速出貨服務；邑新高品質的產品已成功行銷於全世界，主要市場為歐洲、日本、美國…等。

一貫真誠負責的態度是我們的堅持，您的指教與訂貨是我們的榮幸。

YIH SHIN



YIH SHIN COMPANY was confirmation and acceptable by most of customers in all the word since 1975.

創立於 1975 年，邑新公司的產品在全世界已廣受肯定與好評。



General Manger
Yun Ta Liu

PRECISION DURABLE CREATION
精密 耐用 創新

SO THAT, IN ORDER TO PROTECTION THE USERS SAFETY TO WORK, WE CAN OFFER THE SAFETY FINGER GUARD INSERT THE AVAILABLE DIFFERENT KIND OF PRESSER FOOT AS YOU REQUEST.

為了保護使用者在操作上的安全，我們可以根據客人的所需，提供安全護手，裝置在不同型態的押腳上。

PLEASE REFER THE DRAWING AS FOLLOWING
請參考下列代表型式的護手押腳。



TWO NEEDLE COMPENSATING FEET(LEFT) FOR JEANS

P112BL
1/4-1/16

NEW



針距 - 邊距 (NEEDLE) -(EDGE)	
P112BL-1/8	-1/16
P112BL-3/16	-1/16
P112BL-1/4	-1/16
P112BL-5/16	-1/16
P112BL-3/8	-1/16
P112BL-7/16	-1/16
P112BL-1/2	-1/16
P112BL-5/8	-1/16
P112BL-3/4	-1/16
P112BL-7/8	-1/16

P112BL
1/4-1/32

NEW



針距 - 邊距 (NEEDLE) -(EDGE)	
P112BL-1/8	-1/32
P112BL-3/16	-1/32
P112BL-1/4	-1/32
P112BL-5/16	-1/32
P112BL-3/8	-1/32
P112BL-7/16	-1/32
P112BL-1/2	-1/32
P112BL-5/8	-1/32
P112BL-3/4	-1/32
P112BL-7/8	-1/32

TWO NEEDLE COMPENSATING FEET(RIGHT) FOR JEANS

P112BR
1/4-1/16

NEW



針距 - 邊距 (NEEDLE) -(EDGE)	
P112BR-1/8	-1/16
P112BR-3/16	-1/16
P112BR-1/4	-1/16
P112BR-5/16	-1/16
P112BR-3/8	-1/16
P112BR-7/16	-1/16
P112BR-1/2	-1/16
P112BR-5/8	-1/16
P112BR-3/4	-1/16
P112BR-7/8	-1/16

P112BR-1/8	-2.0mm
P112BR-3/16	-2.0mm
P112BR-1/4	-2.0mm

P112BR-1/8	-2.5mm
P112BR-3/16	-2.5mm
P112BR-1/4	-2.5mm

P112BR
1/4-1/32

NEW



針距 - 邊距 (NEEDLE) -(EDGE)	
P112BR-1/8	-1/32
P112BR-3/16	-1/32
P112BR-1/4	-1/32
P112BR-5/16	-1/32
P112BR-3/8	-1/32
P112BR-7/16	-1/32
P112BR-1/2	-1/32
P112BR-5/8	-1/32
P112BR-3/4	-1/32
P112BR-7/8	-1/32

TEFLON BRASSIERE FEET WITH GUIDE(LEFT)

LF112B
1/4-1/16

NEW



針距 - 邊距 (NEEDLE) -(EDGE)	
LF112B-1/8	-1/16
LF112B-3/16	-1/16
LF112B-1/4	-1/16
LF112B-5/16	-1/16
LF112B-3/8	-1/16
LF112B-7/16	-1/16
LF112B-1/2	-1/16
LF112B-5/8	-1/16
LF112B-3/4	-1/16
LF112B-7/8	-1/16

LF112B
1/4-1/32

NEW



針距 - 邊距 (NEEDLE) -(EDGE)	
LF112B-1/8	-1/32
LF112B-3/16	-1/32
LF112B-1/4	-1/32
LF112B-5/16	-1/32
LF112B-3/8	-1/32
LF112B-7/16	-1/32
LF112B-1/2	-1/32
LF112B-5/8	-1/32
LF112B-3/4	-1/32
LF112B-7/8	-1/32

TEFLON BRASSIERE FEET WITH GUIDE(RIGHT)

RF112B
1/4-1/16

NEW



針距 - 邊距 (NEEDLE) - (EDGE)	
RF112B-1/8	-1/16
RF112B-3/16	-1/16
RF112B-1/4	-1/16
RF112B-5/16	-1/16
RF112B-3/8	-1/16
RF112B-7/16	-1/16
RF112B-1/2	-1/16
RF112B-5/8	-1/16
RF112B-3/4	-1/16
RF112B-7/8	-1/16

RF112B
1/4-1/32

NEW



針距 - 邊距 (NEEDLE) - (EDGE)	
RF112B-1/8	-1/32
RF112B-3/16	-1/32
RF112B-1/4	-1/32
RF112B-5/16	-1/32
RF112B-3/8	-1/32
RF112B-7/16	-1/32
RF112B-1/2	-1/32
RF112B-5/8	-1/32
RF112B-3/4	-1/32
RF112B-7/8	-1/32

HINGED BRASSIERE FEET WITH GUIDE(MORE HEAVY)

S570H
1/4-2.6L

NEW



針距 - 邊距 (NEEDLE) - (EDGE)	
S570H-1/8	-2.6L
S570H-3/16	-2.6L
S570H-1/4	-2.6L

S570H
1/4-2.6R

NEW



針距 - 邊距 (NEEDLE) - (EDGE)	
S570H-1/8	-2.6R
S570H-3/16	-2.6R
S570H-1/4	-2.6R

ROLLER BRASSIERE FOOT WITH GUIDE

R-S570
1/4-1.0R

NEW



針距 - 邊距 (NEEDLE) - (EDGE)	
R-S570-1/8	-1.0R
R-S570-3/16	-1.0R
R-S570-1/4	-1.0R

R-S570
1/4-2.0R

NEW



針距 - 邊距 (NEEDLE) - (EDGE)	
R-S570-1/8	-2.0R
R-S570-3/16	-2.0R
R-S570-1/4	-2.0R

DOUBLE NEEDLE WITH REMOVABLE GUIDE FEET

S570GK-1/4

可以調整左、右擋邊尺寸
CAN ADJUSTABLE THE SIZE
OF BOTH SIDE ON THE EDGE



S570GK-1/8
S570GK-3/16
S570GK-1/4
S570GK-5/16
S570GK-3/8
S570GK-1/2

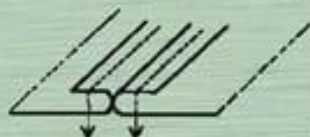

DOUBLE ROLLER FOOT

R-264-1/4
(HM7-1 1/4)

(NEEDLE)-(OUTER WIDTH)
R-232-1/8 (HM7-1 1/8)
R-248-3/16 (HM7-1 3/16)
R-264-1/4 (HM7-1 1/4)
R-280-5/16 (HM7-1 5/16)
R-295-3/8 (HM7-1 3/8)
R-2127-1/2 (HM7-1 1/2)



BRASSIERE FOOT W/GUIDE (THE CLOTH EASY PASS THROUGH)

S570S
1/4-1/32

針距 (NEEDLE)	- 邊距 -(EDGE)
S570S-1/8	-1/32
S570S-3/16	-1/32
S570S-1/4	-1/32
S570S-5/16	-1/32
S570S-3/8	-1/32
S570S-1/2	-1/32



S570SL
1/4-1/32

針距 (NEEDLE)	- 邊距 -(EDGE)
S570SL-1/8	-1/32
S570SL-3/16	-1/32
S570SL-1/4	-1/32
S570SL-5/16	-1/32
S570SL-3/8	-1/32
S570SL-1/2	-1/32



BRASSIERE FOOT W/GUIDE (THE CLOTH EASY PASS THROUGH)

S570S
1/4-1/16

針距 (NEEDLE)	- 邊距 -(EDGE)
S570S-1/8	-1/16
S570S-3/16	-1/16
S570S-1/4	-1/16
S570S-5/16	-1/16
S570S-3/8	-1/16
S570S-1/2	-1/16



S570SL
1/4-1/16

針距 (NEEDLE)	- 邊距 -(EDGE)
S570SL-1/8	-1/16
S570SL-3/16	-1/16
S570SL-1/4	-1/16
S570SL-5/16	-1/16
S570SL-3/8	-1/16
S570SL-1/2	-1/16



BRASSIERE FEET W/GUIDE

S570SD-1/4-1/32



針距 - 邊距 (NEEDLE)-(EDGE)	
S570SD-1/8	-1/32
S570SD-3/16	-1/32
S570SD-1/4	-1/32
S570SD-5/16	-1/32
S570SD-3/8	-1/32
S570SD-1/2	-1/32

S570SD-1/4-1/16



針距 - 邊距 (NEEDLE)-(EDGE)	
S570SD-1/8	-1/16
S570SD-3/16	-1/16
S570SD-1/4	-1/16
S570SD-5/16	-1/16
S570SD-3/8	-1/16
S570SD-1/2	-1/16



DOUBLE NEEDLE ADJUSTABLE EXTRA CLOTH GUIDE FEET

S570-A25



S570-A25 1/8
S570-A25 3/16
S570-A25 1/4
S570-A25 5/16
調整式 5mm~50mm

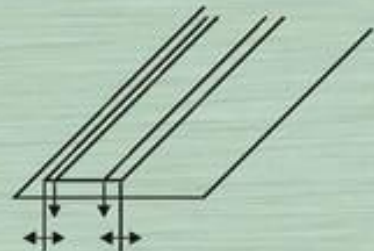

DOUBLE NEEDLE ADJUSTABLE EXTRA CLOTH GUIDE FEET

G10-570

G10-570 1/8
G10-570 3/16
G10-570 1/4
G10-570 5/16
G10-570 3/8



1. 可以調整左、右擋邊尺寸。
2. 車縫布條，可調整大小：0~20mm
1. Can Adjustable The Size of Both Side on The Edge.
2. Seam Cloth Can Adjustable The Tape Size. 0~20mm

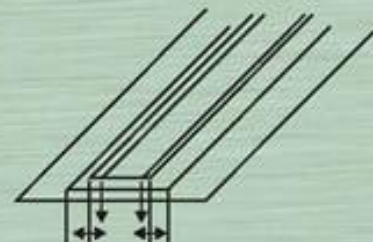

SINGLE NEEDLE CLOTH GUIDE ADJUSTABLE FEET

G10-CRL



1. 可以調整左、右擋邊尺寸。
2. 車縫布條，可調整大小，0~20mm
1. Can Adjustable The Size of Both Side on The Edge.
2. Seam Cloth Can Adjustable The Tape Size. 0~20mm

ADJUSTABLE CONCEALED SEAM COMPENSATING FEET

NR-31G

NL-31G

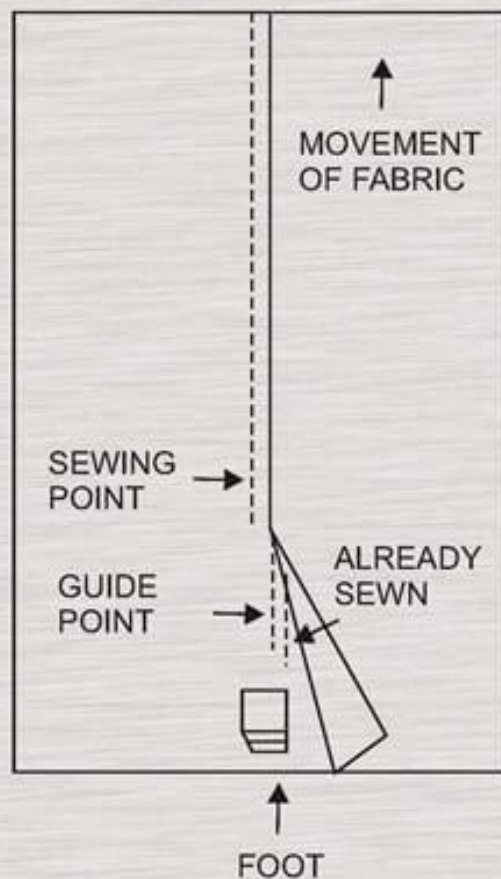

CONCEALED SEAM
FOR SKIRTS OF SLACKS

COMPENSATING FEET FOR KNIT



CR1/16NK

CR1/32NK (210H)
 CR1/16NK (211NH)
 CR1/32K (21H)
 CR1/16K (211H)
 CR3/32K (211 1/2H)
 CR1/8K (212H)
 CR5/32K (212 1/2H)
 CR3/16K (213H)
 CR1/4K (214H)
 CR5/16K (215H)
 CR3/8K (216H)
 CR1/2K (218H)



CL1/16NK

CL1/32NK (220H)
 CL1/16NK (221NH)
 CL1/32K (22H)
 CL1/16K (221H)
 CL3/32K (221 1/2H)
 CL1/8K (222H)
 CL5/32K (222 1/2H)
 CL3/16K (223H)
 CL1/4K (224H)
 CL5/16K (225H)
 CL3/8K (226H)
 CL1/2K (228H)

COMPENSATING FEET



CR1/16N

CR1/32NN (210RN)
 CR 1/16NN(211NN)
 CR1/32N (210R)
 CR1/16N (211N)
 CR1/32E (21R)
 CR1/16E (211R)
 CR3/32E (211 1/2)
 CR1/8E (212R)
 CR5/32E (212 1/2)
 CR3/16E (213R)
 CR1/4E (214R)
 CR5/16E (215R)
 CR3/8E (216R)
 CR1/2E (218R)



CL1/16N

CL1/32NN(220LN)
 CL 1/16NN(221NN)
 CL1/32N (220L)
 CL1/16N (221N)
 CL1/32E (22L)
 CL1/16E (221L)
 CL3/32E (221 1/2)
 CL1/8E (222L)
 CL5/32E (222 1/2)
 CL3/16E (223L)
 CL1/4E (224L)
 CL5/16E (225L)
 CL3/8E (226L)
 CL1/2E (228L)

COMPENSATING FEET FOR KNIT (STRENGTH)

USE ON THICKNESS OF FABRICS THE SIDE SCREW
 CAN EASY HOLD THE GUIDE ,SO THE CLOTH CAN SMOOTHLY



CR1/16NS

CR1/32NS CR3/16ES
 CR1/16NS CR1/4ES
 CR1/32ES CR5/16ES
 CR1/16ES CR3/8ES
 CR3/32ES CR1/2ES
 CR1/8ES
 CR5/32ES



CL1/16NS

CL1/32NS CL5/32ES
 CL1/16NS CL3/16ES
 CL1/32ES CL1/4ES
 CL1/16ES CL5/16ES
 CL3/32ES CL3/8ES
 CL1/8ES CL1/2ES

MORE HEAVY
 特厚物用



CL 1/32NS-2

CL 1/32NS-1

MORE HEAVY
 特厚物用

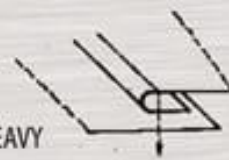

COMPENSATING FEET



CR-15N

CR-10N -1.0mm
 CR-15N -1.5mm
 CR-10 -1.0mm
 CR-15 -1.5mm
 CR-20 -2.0mm
 CR-25 -2.5mm
 CR-30 -3.0mm
 CR-40 -4.0mm
 CR-50 -5.0mm
 CR-60 -6.0mm
 CR-65 -6.5mm
 CR-70 -7.0mm
 CR-80 -8.0mm
 CR-90 -9.0mm
 CR-100 -10 mm
 CR-110 -11 mm
 CR-130 -13 mm



CL-15N

CL-10N -1.0mm
 CL-15N -1.5mm
 CL-10 -1.0mm
 CL-15 -1.5mm
 CL-20 -2.0mm
 CL-25 -2.5mm
 CL-30 -3.0mm
 CL-40 -4.0mm
 CL-50 -5.0mm
 CL-60 -6.0mm
 CL-65 -6.5mm
 CL-70 -7.0mm
 CL-80 -8.0mm
 CL-90 -9.0mm
 CL-100 -10 mm
 CL-110 -11 mm
 CL-130 -13 mm

COMPENSATING FEET(SHORT TOE)



CR1/16

CR1/32
 CR1/16
 CR3/32
 CR1/8
 CR5/32
 CR3/16
 CR1/4
 CR5/16
 CR3/8
 CR1/2



CL1/16

CL1/32
 CL1/16
 CL3/32
 CL1/8
 CL5/32
 CL3/16
 CL1/4
 CL5/16
 CL3/8
 CL1/2

COMPENSATING FEET FOR KNIT (STRENGTH)

USE ON THICKNESS OF FABRICS THE SIDE SCREW CAN EASY HOLD THE GUIDE ,SO THE CLOTH CAN SMOOTHLY

CR 1/32S



SHORT TOE

(RIGHT)	(LEFT)
CR1/32S	CL1/32S
CR1/16S	CL1/16S
CR3/32S	CL3/32S
CR1/8S	CL1/8S
CR5/32S	CL5/32S
CR3/16S	CL3/16S
CR1/4S	CL1/4S
CR5/16S	CL5/16S
CR3/8S	CL3/8S
CR1/32S-1	CL1/32S-1
CR1/32S-2	CL1/32S-2

ADJUSTABLE PRESSET FOOT (EASY OPPERATE DON'T STOP)

P351KS

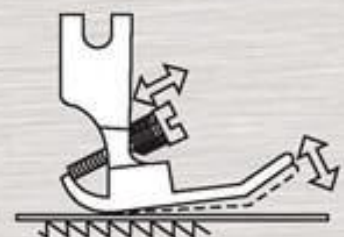

COMPENSATING FEET(DOUBLE)

CD-3/16 DOUBLE



CDN-00 (230)
 CD-00 (23)
 CD-10 (1.0mm)
 CD-15 (1.5mm)
 CD-20 (2.0mm)
 CDN-1/32(D23N)
 CD-1/32 (D23)
 CDN-1/16(D231N)
 CD-1/16 (D231)
 CD-1/8 (D232)
 CD-3/16 (D233)
 CD-1/4 (D234)

23-14-24 DOUBLE



23-13-23
 (1/32-3/16-3/16)
 231-13-23
 (1/16-3/16-3/16)
 23-14-24
 (1/32-1/4-1/4)
 231-14-24
 (1/16-1/4-1/4)
 23-15-25
 (1/32-5/16-5/16)
 231-15-25
 (1/16-5/16-5/16)

990474-0-01

DUAL COMPENSATING FEET

211-16



21-13 (1/32x3/16)
 211-13 (1/16x3/16)
 21-14 (1/32x1/4)
 211-14 (1/16x1/4)
 21-15 (1/32x5/16)
 211-15 (1/16x5/16)
 21-16 (1/32x3/8)
 211-16 (1/16x3/8)
 21-18 (1/32x1/2)
 211-18 (1/16x1/2)

990474-0-01

8-48



8-32 (1/32x1/8)
 8-48 (1/32x3/16)
 8-64 (1/32x1/4)
 8-80 (1/32x5/16)
 16-32 (1/16x1/8)
 16-48 (1/16x3/16)
 16-64 (1/16x1/4)
 16-80 (1/16x5/16)



PRESSER FOOT WITH GUIDE

SP18-1/4



SP18- 1/32 (1.0mm)
 SP18- 1/16 (1.6mm)
 SP18- 3/32 (2.4mm)
 SP18- 1/8 (3.2mm)
 SP18- 5/32 (4.0mm)
 SP18- 3/16 (4.8mm)
 SP18- 1/4 (6.4mm)
 SP18- 5/16 (8.0mm)
 SP18- 3/8 (9.6mm)
 SP18- 1/2 (12.7mm)

SP18L-1/4



SP18L- 1/32 (1.0mm)
 SP18L- 1/16 (1.6mm)
 SP18L- 3/32 (2.4mm)
 SP18L- 1/8 (3.2mm)
 SP18L- 5/32 (4.0mm)
 SP18L- 3/16 (4.8mm)
 SP18L- 1/4 (6.4mm)
 SP18L- 5/16 (8.0mm)
 SP18L- 3/8 (9.6mm)
 SP18L- 1/2 (12.7mm)

COMPENSATING TEFLON FEET (LIGHT)



RF1/16NK

RF1/32NK (PF210)
 RF1/16NK (PF211N)
 RF1/32K (PF21R)
 RF1/16K (PF211R)
 RF3/32K (PF211 1/2)
 RF1/8K (PF212R)
 RF5/32K (PF212 1/2)
 RF3/16K (PF213R)
 RF1/4K (PF214R)
 RF5/16K (PF215R)
 RF3/8K (PF216R)
 RF1/2K (PF218R)

薄物 (LIGHT)



LF1/16NK

LF1/32NK (PF220L)
 LF1/16NK (PF221N)
 LF1/32K (PF22L)
 LF1/16K (PF221L)
 LF3/32K (PF221 1/2)
 LF1/8K (PF222L)
 LF5/32K (PF222 1/2)
 LF3/16K (PF223L)
 LF1/4K (PF224L)
 LF5/16K (PF225L)
 LF3/8K (PF226L)
 LF1/2K (PF228L)

薄物 (LIGHT)

COMPENSATING TEFLON FEET (REGULAR)



RF1/16N

RF1/32N
 RF1/16N
 RF1/32
 RF1/16
 RF3/32
 RF1/8
 RF5/32
 RF3/16
 RF1/4
 RF5/16
 RF3/8
 RF1/2



LF1/16N

LF1/32N
 LF1/16N
 LF1/32
 LF1/16
 LF3/32
 LF1/8
 LF5/32
 LF3/16
 LF1/4
 LF5/16
 LF3/8
 LF1/2

COMPENSATING TEFLON FEET (REGULAR)



RF-15N

RF-10N -1.0mm
 RF-15N -1.5mm
 RF-10 -1.0mm
 RF-15 -1.5mm
 RF-20 -2.0mm
 RF-25 -2.5mm
 RF-30 -3.0mm
 RF-40 -4.0mm
 RF-50 -5.0mm
 RF-60 -6.0mm
 RF-65 -6.5mm
 RF-70 -7.0mm
 RF-80 -8.0mm
 RF-90 -9.0mm
 RF-100 -10 mm
 RF-120 -12 mm
 RF-130 -13 mm



LF-15N

LF-10N -1.0mm
 LF-15N -1.5mm
 LF-10 -1.0mm
 LF-15 -1.5mm
 LF-20 -2.0mm
 LF-25 -2.5mm
 LF-30 -3.0mm
 LF-40 -4.0mm
 LF-50 -5.0mm
 LF-60 -6.0mm
 LF-65 -6.5mm
 LF-70 -7.0mm
 LF-80 -8.0mm
 LF-90 -9.0mm
 LF-100 -10 mm
 LF-120 -12 mm
 LF-130 -13 mm

TEFLON HINGED RAISING FEET



CF811

RIGHT
 CF810 -1/32
 CF811 -1/16
 CF8115 -3/32
 CF812 -1/8
 CF813 -3/16
 CF814 -1/4
 CF815 -5/16
 CF816 -3/8
 CF818 -1/2



CF811L

LEFT
 CF810L -1/32
 CF811L -1/16
 CF8115L -3/32
 CF812L -1/8
 CF813L -3/16
 CF814L -1/4
 CF815L -5/16
 CF816L -3/8
 CF818L -1/2

TEFLON FEET (LIGHT W/TAIL)



CF-251
 (PF-251)

CF-231-HEAVY
 (PF-231-HEAVY- 厚物)
 CF-241-MEDIUM
 (PF-241-MEDIUM- 中物)
 CF-251-LIGHT
 (PF-251-LIGHT- 薄物)

TEFLON FEET (LIGHT WITHOUT TAIL)



CF-151
 (PF-151)

CF-131-HEAVY
 (PF-131-HEAVY- 厚物)
 CF-141-MEDIUM
 (PF-141-MEDIUM- 中物)
 CF-151-LIGHT
 (PF-151-LIGHT- 薄物)

TEFLON FEET (LIGHT)

CFK-161
 (PFK-161)

CFK-161-LIGHTEST
 (PFK-161-LIGHTEST)
 CFK-261-LIGHTEST W/TAIL
 (PFK-261-LIGHTEST W/TAIL)



SOLID THE CLOTH
 PROOF MOTION

TEFLON FOOT (LINE ON THE CENTER EDGE GUIDE)

CF00
 (PF00)



TEFLON FEET (ZIPPER)

CF36N



4.8mm

CF36



8mm

CF36W



10mm

TEFLON FEET (ZIPPER)

CF36LN



4.8mm

CF36L



8mm

CF36LW



10mm

TEFLON FEET (ZIPPER)

CF361



8mm



CF360



8mm



TEFLON FEET (ZIPPER)

CF363



5mm

CF3CH



5mm

TEFLON FEET (ZIPPER)

CF3CHS



5mm

CF363V



5mm

TEFLON FEET (ZIPPER)

CF58N

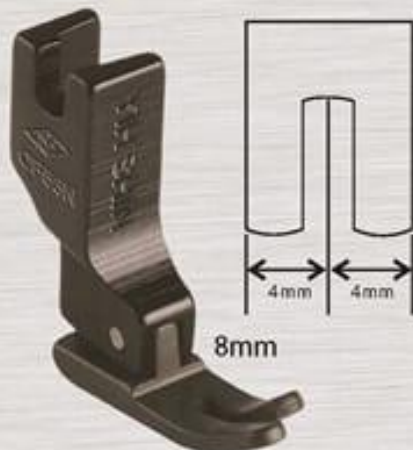

8mm

CF35



11mm

CF351



11mm

TEFLON INVISIBLE FOOT

CF518N
(PF518N)



CF518L
(PF518L)



HINGED RAISING FEET

SA-75

NEW



SA....	A105 Bias Tape Sizes
SA-40	10
SA-45	18,20
SA-55	22,24
SA-65	26,28
SA-75	30,32
SA-85	-
SA-95	36
SA-105	40
SA-130	45
SA-150	50
SA-200	-
SA-250	-

HINGED RAISING FEET

P815H

NEW



P810H	-1.0mm(1/32)
P815H	-1.5mm(1/16)
P820H	-2.0mm(5/64)
P825H	-2.5mm(3/32)
P830H	-3.0mm(1/8)
P840H	-4.0mm(5/32)
P850H	-5.0mm(3/16)
P860H	-6.0mm(15/64)
P870H	-7.0mm(9/32)
P880H	-8.0mm(5/16)
P890H	-9.0mm(23/64)
P8100H	-10.0mm(25/64)
P8110H	-11.0mm(7/16)
P8120H	-12.0mm(15/32)
P8130H	-13.0mm(33/64)

HINGED RAISING FEET

P811

RIGHT

P810	(12463H 1/32)
P811	(12463H 1/16)
P8115	(12463H 3/32)
P812	(12463H 1/8)
P813	(12463H 3/16)
P814	(12463H 1/4)
P815	(12463H 5/16)
P816	(12463H 3/8)
P818	(12463H 1/2)



P811L

LEFT

P810L	(L12463H 1/32)
P811L	(L12463H 1/16)
P8115L	(L12463H 3/32)
P812L	(L12463H 1/8)
P813L	(L12463H 3/16)
P814L	(L12463H 1/4)
P815L	(L12463H 5/16)
P816L	(L12463H 3/8)
P818L	(L12463H 1/2)



HINGED PIPING FEET

P69RH3/16 RIGHT

P69RH1/16 (R36069H1/16)
 P69RH1/8 (R36069H1/8)
 P69RH3/16 (R36069H3/16)
 P69RH1/4 (R36069H1/4)



P69LH3/16 LEFT

P69LH1/16 (L36069H1/16)
 P69LH1/8 (L36069H1/8)
 P69LH3/16 (L36069H3/16)
 P69LH1/4 (L36069H1/4)



SPECIAL PIPING FEET

P31C1/4 RIGHT

P31C1/8 (12435R 1/8)
 P31C3/16 (12435R 3/16)
 P31C1/4 (12435R 1/4)



P301C1/4 LEFT

P301C1/8 (31358L 1/8)
 P301C3/16 (31358L 3/16)
 P301C1/4 (31358L 1/4)



SOLID PIPING FEET

P69R3/8 RIGHT

P69R1/16 (36069R 1/16)
 P69R1/8 (36069R 1/8)
 P69R3/16 (36069R 3/16)
 P69R1/4 (36069R 1/4)
 P69R3/8 (36069R 3/8)
 P69R1/2 (36069R 1/2)
 (26650R 1/8)



P69L3/8 LEFT

P69L1/16 (36069L 1/16)
 P69L1/8 (36069L 1/8)
 P69L3/16 (36069L 3/16)
 P69L1/4 (36069L 1/4)
 P69L3/8 (36069L 3/8)
 P69L1/2 (36069L 1/2)
 (26650L 1/8)



SOLID PIPING FEET(DOUBLE)

P69D1/4 (DOUBLE)

P69D1/16 (36069DG 1/16)
 P69D1/8 (36069DG 1/8)
 P69D3/16 (36069DG 3/16)
 P69D1/4 (36069DG 1/4)
 (26650DG 1/8)



SPECIAL PIPING FOOT

P37M

P37
 -SMALL GROVE -2mm
 P37M
 -MED. GROVE -3mm
 P37W
 -LARGE GROVE -4mm



BINDER FOOT

P39

PLAIN



BINDER FEET

A10-01 (12142C)

A10-01- 3/4
 A10-01-7/8
 A10-01-1"
 A10-01-1 1/8
 A10-01-1 1/4
 A10-01-1 3/8
 A10-01-1 1/2

size	A10-01(size)
16mm	A10-01-3/4
18mm	
20mm	
22mm	A10-01-7/8
24mm	
26mm	A10-01-1"
28mm	
30mm	A10-01-1 1/8
32mm	
36mm	A10-01-1 1/4
40mm	A10-01-1 1/2
45mm	
50mm	



BINDER FOOT (HINGED)

S70F-1/8

S70F-1/16
 S70F-1/8
 S70F-3/16
 S70F-1/4
 S70F-5/16
 S70F-3/8
 S70F-1/2



GUIDE FEET FOR HEMMERS

P3613

SIZE	A
P3613-9/32	(7mm)
P3619-1/2	(13mm)
P3622-5/8	(16mm)
P3625-3/4	(19mm)
P3610-15/64	(6mm)
P3620-13/32	(10mm)

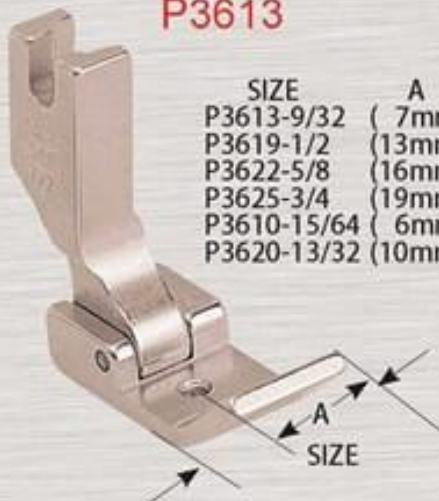

P3811(S538)

SIZE	A
P3811 (S538-1/4)	1/4"
P3819 (S539-1/2)	1/2"
P3822 (5/8)	5/8"
P3825 (S540-3/4)	3/4"
(S541-1 5/16")	1 5/16"

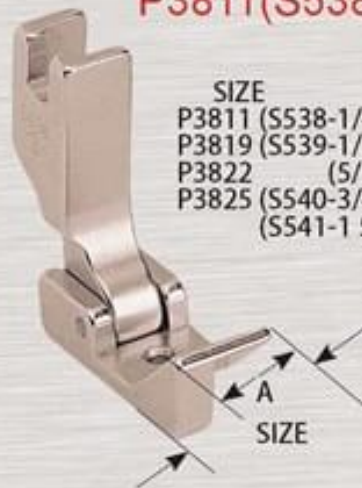

COMPENSATING BINDING FEET

CB-3/4



CB-3/4 (601)
 CB-1" (602)
 CB-1 1/8 (603)
 CB-1 1/4 (604)

size	CB (size)
16mm	CB-3/4
18mm	
20mm	
22mm	
24mm	CB-1"
26mm	
28mm	
30mm	
32mm	CB-1 1/4
36mm	
40mm	
45mm	
50mm	

BINDING FOOT

S545(P38)



HEMMING & FOLDING FEET

S543(CHN)



S544(CHW)



12142AHB



SR-1



SOLID FOLDING FEET

P311
(12143)



P33
(12142)



P34



P344



REGULAR SHIRRING FEET

P50



P50N (120828N) -1.5mm
 P50 (120828) -1.5mm
 P50M (120828M) -2.0mm
 P50H (120828H) -2.8mm

3 SCROLL HEMMER FEET

2 1/2



1 (160344-1/16)
 1 1/2 (120802-5/64)
 2 (120938-3/32)
 2 1/2 (120803-1/8)
 02 (1/8)(HEAVY)
 3 (120804-5/32)
 4 (120805-3/16)
 04 (3/16)(HEAVY)
 5 (120940-7/32)
 6 (120806-1/4)
 06 (1/4)(HEAVY)

BINDER FEET

S532(P312SB)



ADJUSTABLE TAPE FEET

S534(A225)



HINGED TUBE FEET

S10C-1/2

S10C-1/8 (P318C 1/8)
 S10C-3/16 (P3316C 3/16)
 S10C-1/4 (P314C 1/4)
 S10C-5/16 (P3516C 5/16)
 S10C-3/8 (P338C 3/8)
 S10C-1/2 (P312C 1/2)
 S10C-5/8 (P358C 5/8)
 S10C-3/4 (P334C 3/4)
 S10C-1" (P325C 1")



S10R-1/2

S10R-1/8 (P318R 1/8)
 S10R-3/16 (P3316R 3/16)
 S10R-1/4 (P314R 1/4)
 S10R-5/16 (P3516R 5/16)
 S10R-3/8 (P338R 3/8)
 S10R-1/2 (P312R 1/2)
 S10R-5/8 (P358R 5/8)
 S10R-3/4 (P334R 3/4)
 S10R-1" (P325R 1")



HINGED TUBE FEET

S10L-1/2

S10L-1/8	(P318L 1/8)
S10L-3/16	(P3316L 3/16)
S10L-1/4	(P314L 1/4)
S10L-5/16	(P3516L 5/16)
S10L-3/8	(P338L 3/8)
S10L-1/2	(P312L 1/2)
S10L-5/8	(P358L 5/8)
S10L-3/4	(P334L 3/4)
S10L-1"	(P325L 1")



TOP STITCH GUIDE FEET

P14

P10	(36465-1/32)
P11	(36465-1/16)
P115	(36465-3/32)
P12	(36465-1/8)
P13	(36465-3/16)
P14	(36465-1/4)
P15	(36465-5/16)
P16	(36465-3/8)
P18	(36465-1/2)
P01	(36464N)(P10~P14)
P01W	(36464W)(P15~P18)



SHIRRING FEET

S952 (P952)



S950 (P950)



P5 (P5R)



P5W



SOLID ZIPPER FEET

S530S



S531L



P3 (165010)



P3C (40322)



SOLID ZIPPER FEET

P3CS
(40322CS)



5mm

HINGED ZIPPER FEET

P363V
(165010H)



5mm

P363
(40322SH)



5mm

SOLID CORDING FEET

P311N
(12435N)



4.8mm

P301N
(31358N)



4.8mm

P31
(12435W)



7.5mm

P301
(31358W)



7.5mm

HINGED CORDING FEET

P36N
(12435HN)



4.8mm

P36
(12435HW)



8mm

P36W
(12435HXW)



10mm

D36NH



DOUBLE

5mm

HINGED CORDING FEET

P36LN
(31358HN)



P36L
(31358HW)



P36LW
(31358HXW)



D36H



HINGED ZIPPER FEET

P360
(121947H)



P361
(121950H)



ZIPPER FOOT

S510
ENTER GUIDE FOOT



HINGED INVISIBLE ZIPPER FEET

S518L



S518N



S518NE



S518



HINGED INVISIBLE ZIPPER FEET

S518H

S518W

NEW

SIZE -A
S518W -3.0mm
S518XW-3.5mm



2.5mm



A 3.0mm

INVISIBLE ZIPPER FEET

S518S

S518A



2mm



2mm~5mm

HINGED STANDARD FEET

P946
(121946)



7mm

P58N
(142058N)



8mm

P58
(142058)



8.5mm

P58W
(142058W)



9mm

ZIPPER FEET

P35
(24983)



11mm

P35K
(24983K)



LIGHT (薄物用)

11mm

P144H
(12144H)



11mm

P193
(19336)



13mm

SIZE
P144H
(12144H)
P144HL
(12144HLD)
P144HLB
(12144HLB)

HINGED STANDARD FOOT

P351
(52427)



SIZE
P351 -2.0mm
P351H-3.0mm
(MORE HEAVY)

P352



P351K



LIGHT
(薄物用)

STANDARD FEET

P127
(127233)



QUILTER & GUIDE FEET

S524

7/32"~1"



P81

(S523)
1/32"~3/4"



P801

1/32"~3/4"



P803

3/16"~7/8"



QUILTER & GUIDE FEET

P723

(S521)
3/16"~2"

Hinged Quilter Foot With
Right & Left Guides



HINGED FOOT

113280

(113280-0-01)



150789

(150789-0-01)



FOOT FOR COLLARS
& BACK BINDING
SOLID BLANK FOOT

147308(ART.570)



HINGED STANDARD FOOT

SP-44

SP-60(S402)

SP-61(S801)



SOLID BLANK FEET

SP-62
(S802)

SP-63
(S803)

SP-64
(S804)

SP-65
(S400)



QUILTER FEET

160342



HINGED PRESSER FEET (HEAVY W/GUARD)

B1511-543-BBA



特厚物用 MORE HEAVY

HINGED PRESSER FEET

B1524-522-NBO-A



STANDARD HINGED FEET

B1524-012-
OAO



B1524-012-
BBA



B1524-012-
OBO



51742-G

51742
(91-051742-03)



NYLON RING FOOT

S515
(CF2-S)



SR-DB-W
(TRF-1)



NYLON RING FOOT

SR-DB-R



SR-DB-L



ROLLER PRESSER FOOT

SDRF



ROLLER FEET

SPK-3



ROLLER FEET WITH GUIDE

R-811



R-810 -1/32
R-811 -1/16
R-812 -1/8
R-813 -3/16
R-814 -1/4
R-815 -5/16
R-816 -3/8

R-811L



R-810L -1/32
R-811L -1/16
R-812L -1/8
R-813L -3/16
R-814L -1/4
R-815L -5/16
R-816L -3/8

ROLLER FEET

R2E



ROLLER FEET (SPECIAL)

R-3



R-1 LIGHT- 薄物
(HM1-1)
R-2 MEDIUM- 中物
(HM1-2)
R-3 HEAVY- 厚物
(HM1-3)

ROLLER FEET (SPECIAL)

R-36N(HM 2-3)

R-36LN(HM 2-4)



ROLLER FEET (SPECIAL)

R-36(HM 2-1)

R-36L(HM 2-2)



ROLLER FEET (SPECIAL)

R-361(HM 1-4)

R-360(HM 1-6)



ROLLER FEET (SPECIAL)

R-36LW

R-36W



ROLLER COMPENSATING FEET (SPECIAL)

R-1/16R

R-1/16L

R-1/32RN(HM1/32)
R-1/16RN(HM1/16)
R-1/32R (1/32)
R-1/16R (1/16)
R-5/64R (HM5/64)
R-3/32R (HM3/32)

R-1/8R (HM1/8)
R-5/32R (HM5/32)
R-3/16R (HM3/16)
R-1/4R (HM1/4)
R-5/16R (HM5/16)

R-1/32LN
R-1/16LN
R-1/32L
R-1/16L
R-5/64L

R-3/32L
R-1/8L
R-3/16L
R-1/4L
R-5/16L



ROLLER FOOT

K1 NEEDLE PLATE
K2 FEED DOG
K3 FOOT

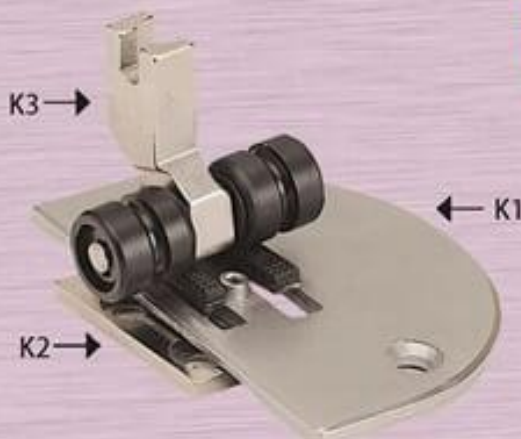

MANUL INVISIBLE BLADE FOOT (CUTTER THREAD)

YS-37 (NP-37)

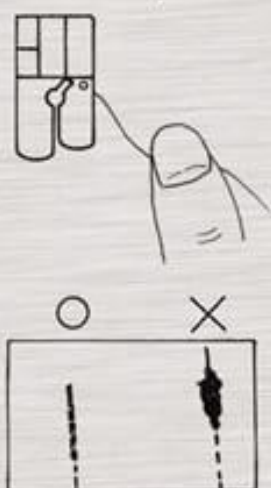

SPECIAL DESIGN FOOT (CUTTER THREAD)

(W/TAILO)
368611

(W/O TAIL)
368607



QUILTER & GUIDE FEET

P35G



可以調整左、右擋邊尺寸
CAN ADJUSTABLE THE SIZE OF
BOTH SIDE ON THE EGDE

TEFLON FEET

NT-18

NT-18B



TEFLON COMPENSATING FOOT

TCR 1/32



TCR1/32N (MT210)
TCR1/16N (MT211N)
TCR1/32 (MT21R)
TCR1/16 (MT211)
TCR3/32 (MT211 1/2)
TCR1/8 (MT212)
TCR3/16 (MT213)
TCR1/4 (MT214)
TCR5/16 (MT215)
TCR3/8 (MT216)
TCR1/2 (MT218)

TCL 1/32



TCL1/32N (MT220)
TCL1/16N (MT221N)
TCL1/32 (MT22)
TCL1/16 (MT221)
TCL3/32 (MT221 1/2)
TCL1/8 (MT222)
TCL3/16 (MT223)
TCL1/4 (MT224)
TCL5/16 (MT225)
TCL3/8 (MT226)
TCL1/2 (MT228)

TEFLON FOOT

T350
T350B

T35
T35B

T35W
T35WB

T35C
T35CB



TEFLON FOOT

T35CW
T35CWB

T363
T363B

T36N
T36NB

T36LN
T36LNB



TEFLON FOOT

T36
T36B

T36L
T36LB

MT-1
MT-2

24983T



DOMESTIC HEMMER FEET

H15SH(2858)



H15SH 2.0mm(2858)
H15SH 2.5mm(2858)
H15SH 3.0mm(2858)
H15SH 4.0mm(2858)

DOMESTIC PIPING FEET

H15-69HL

H15-69HL 1/4 -6.4mm
H15-69HL 1/8 -3.2mm
H15-69HL 3/16 -4.8mm



DOMESTIC ZIG-ZAG FEET

H15Z



COMPENSATING FEET FOR DOMESTIC MACHINES

H15



H10-1.0mm
H15-1.5mm (ART.1926/1)
H20-2.0mm
H25-2.5mm (ART.1926/2)
H30-3.0mm (ART.1926/3)
H40-4.0mm (ART.1926/4)
H50-5.0mm (ART.1926/5)
H60-6.0mm (ART.1926/6)
H80-8.0mm

ZIG-ZAG DOUBLE COMPENSATING FEET

H15ZZ



H15ZZ-3.0mm(ART.1929)
H15ZZ-6.0mm(ART.1929)

UNION SPECIAL HINGED FEET

US12435HN

SIZE
61220J
61220P
61320J
US12435HN
US12435HW
US31358HN
US31358HW
US403225H



NEEDLE FEED FEET



COLLAR BAND TOP STITCH GUIDE

360A-NF
(360-A)

NEW



TEFLON FOOT

LF221-NF

NEW



LF220-NF(NARROW-1/32)
LF221N-NF(NARROW-1/16)
LF22L-NF-1/32
LF221-NF-1/16
LF221 1/2-NF-3/32
LF222-NF-1/8
LF223-NF-3/16
LF224-NF-1/4
LF225-NF-5/16
LF226-NF-3/8
LF228-NF-1/2

RF211-NF

NEW



RF210-NF(NARROW-1/32)
RF211N-NF(NARROW-1/16)
RF21R-NF-1/32
RF211-NF-1/16
RF211 1/2-NF-3/32
RF212-NF-1/8
RF213-NF-3/16
RF214-NF-1/4
RF215-NF-5/16
RF216-NF-3/8
RF218-NF-1/2

NEEDLE FEED COMPENSATING FOOT

CL25-NF

NEW



CL10N-NF
CL15N-NF
CL10 -NF
CL15 -NF
CL20 -NF
CL25 -NF
CL30 -NF
CL40 -NF
CL50 -NF
CL60 -NF
CL70 -NF
CL80 -NF
CL90 -NF
CL100-NF
CL110-NF
CL120-NF
CL130-NF

CR25-NF

NEW



CR10N-NF
CR15N-NF
CR10 -NF
CR15 -NF
CR20 -NF
CR25 -NF
CR30 -NF
CR40 -NF
CR50 -NF
CR60 -NF
CR70 -NF
CR80 -NF
CR90 -NF
CR100-NF
CR110-NF
CR120-NF
CR130-NF

NEEDLE FEED COMPENSATING FOOT

PFAFFCL.461,481 DURKOPP CL.272

220-NF



220- NF(NARROW-1/32)
221N- NF(NARROW-1/16)
22L- NF(ART.1649/1-1/32)
221- NF(ART.1649/3-1/16)
222- NF(ART.1649/5-1/8)
223- NF(ART.1649/7-3/16)
224- NF(ART.1649/9-1/4)
225- NF(ART.1649/11-5/16)
226- NF(ART.1649/13-3/8)
228- NF(ART.1649/15-1/2)

210-NF



210- NF(NARROW-1/32)
211N- NF(NARROW-1/16)
21R- NF(ART.1649/2-1/32)
211- NF(ART.1649/4-1/16)
212- NF(ART.1649/6-1/8)
213- NF(ART.1649/8-3/16)
214- NF(ART.1649/10-1/4)
215- NF(ART.1649/12-5/16)
216- NF(ART.1649/14-3/8)
218- NF(ART.1649/16-1/2)

COMPENSATING FEET FOR KNIT
 USE ON THICKNESS OF FABRICS THE SIDE SCREW
 CAN EASY HOLD THE GUIDE ,SO THE CLOTH CAN SMOOTHLY



211S-NF

- 210S -NF(NARROW-1/32)
- 211NS- NF(NARROW-1/16)
- 21RS -NF(ART.1649/2-1/32)
- 211S -NF(ART.1649/4-1/16)
- 212S -NF(ART.1649/6-1/8)
- 213S -NF(ART.1649/8-3/16)
- 214S -NF(ART.1649/10-1/4)
- 215S -NF(ART.1649/12-5/16)
- 216S -NF(ART.1649/14-3/8)
- 218S -NF(ART.1649/16-1/2)



221S-NF

- 220S -NF(NARROW-1/32)
- 221NS- NF(NARROW-1/16)
- 22LS -NF(ART.1649/1-1/32)
- 221S -NF(ART.1649/3-1/16)
- 222S -NF(ART.1649/5-1/8)
- 223S -NF(ART.1649/7-3/16)
- 224S -NF(ART.1649/9-1/4)
- 225S -NF(ART.1649/11-5/16)
- 226S -NF(ART.1649/13-3/8)
- 228S -NF(ART.1649/15-1/2)

NEEDLE FEED W/GUIDE HINGED FEET

SP18-NF1/16



- SP18-NF 1/32 =1.0mm
- SP18-NF 1/16 =1.6mm
- SP18-NF 3/32 =2.4mm
- SP18-NF 1/8 =3.2mm
- SP18-NF 5/32 =4.0mm
- SP18-NF 3/16 =4.8mm
- SP18-NF 1/4 =6.4mm
- SP18-NF 5/16 =8.0mm
- SP18-NF 3/8 =9.6mm

SP18L-NF 1/16



- SP18L-NF 1/32=1.0mm
- SP18L-NF 1/16=1.6mm
- SP18L-NF 3/32=2.4mm
- SP18L-NF 1/8 =3.2mm
- SP18L-NF 5/32=4.0mm
- SP18L-NF 3/16=4.8mm
- SP18L-NF 1/4 =6.4mm
- SP18L-NF 5/16=8.0mm
- SP18L-NF 3/8 =9.6mm

NEEDLE FEED W/GUIDE HINGED FEET

P811-NF1/16



- P810 -NF 1/32 = 1.0mm
- P811 -NF 1/16 = 1.6mm
- P8115 -NF 3/32 = 2.4mm
- P812 -NF 1/8 = 3.2mm
- P813 -NF 3/16 = 4.8mm
- P814 -NF 1/4 = 6.4mm
- P815 -NF 5/16 = 8.0mm
- P816 -NF 3/8 = 9.6mm

P821-NF 1/16



- P820 -NF 1/32 =1.0mm
- P821 -NF 1/16 =1.6mm
- P8215 -NF 3/32 = 2.4mm
- P822 -NF 1/8 = 3.2mm
- P823 -NF 3/16 = 4.8mm
- P824 -NF 1/4 = 6.4mm
- P825 -NF 5/16 = 8.0mm
- P826 -NF 3/8 = 9.6mm

NEEDLE FEED PIPING HINGED FEET



P69RH-NF 1/4

P69RH-NF 1/8
 P69RH-NF 3/16
 P69RH-NF 1/4
 P69RH-NF 5/16
 P69RH-NF 3/8
 P69RH-NF 1/2



P69LH-NF 1/4

P69LH-NF 1/8
 P69LH-NF 3/16
 P69LH-NF 1/4
 P69LH-NF 5/16
 P69LH-NF 3/8
 P69LH-NF 1/2

NEEDLE FEED W/GUIDE HINGED FEET

NR31G-NF



NL31G-NF



990474-0-01



990474-0-01

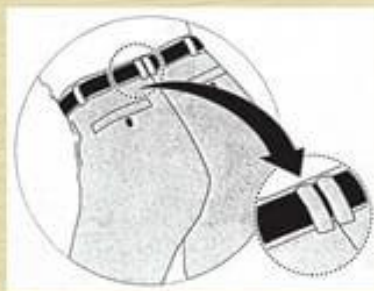

CONCEALED SEAM
 FOR SKIRTS OF SLACKS

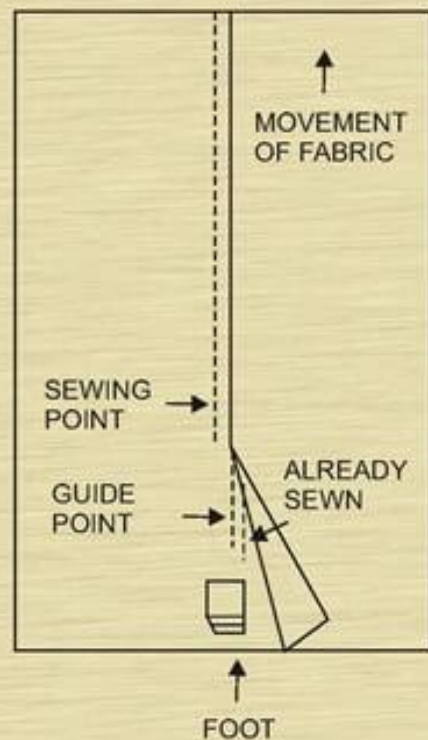

NEEDLE FEED W/GUIDE HINGED FEET

G10-NF



1. 可以調整左、右擋邊尺寸。
2. 車縫布條，可調整大小，0~20mm
1. Can Adjustable The Size of Both Side on The Edge.
2. Seam Cloth Can Adjustable The Tape Size. 0~20mm

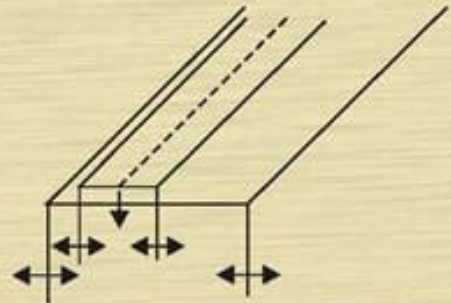

NEEDLE FEED ZIPPER FEET

P35G-NF



可以調整左、右擋邊尺寸
CAN ADJUSTABLE THE
SIZE OF BOTH SIDE ON
THE EGDE.

NEEDLE FEED ROLLER FEET

R-351-NF
(HM 1-5)



12mm

HINGED QUILTER FOOT WITH RIGHT & LEFT GUIDES FOR NEEDLE FEED

P723-NF



5~50mm

NEEDLE FEED ZIPPER FEET

P363-NF
(S363-NF)
(ART.1680)



SIZE
P363-NF
5.4mm
(ART.1680)
P363W-NF
7.0mm
(ART.1688)

5.4mm

P36N-NF
(S5000N)
(ART.1684)



5.0mm

P36-NF
(S8000N)
(ART.1690)



8.0mm

P361-NF
(S6020N)



8.0mm

HINGED FEET FOR NEEDLE FEED MACHINE (ONE NEEDLE)

P363VNF



5.0mm

P36LN-NF

(S0050N)
(ART.1683)



5.0mm

P36L-NF

(S0080)
(ART.1689)



8.0mm

P360-NF

(S2060N)



8.0mm

NEEDLE FEED FEET

P351N-NF

(S351NF)



9mm

4.5mm
4.5mm

P351-NF

(S351NF)



11mm

P127-NF

(ART.6643)



12mm

P127WK-NF

LIGHT
薄物用



14.5mm

NEEDLE FEED FEET

P36D-NF

(ART.6648)
DOUBLE



7mm

P27

(S5050N)
(149027)
(149085)



11mm

P127W-NF

(ART.6644)



14.5mm

12142AHBNF



NEEDLE FEED ZIPPER FEET

B1524-412-
OAO



B1524-412-
OBO (410916)



B1524-415-
BBA



B1524-041-
EAO



NEEDLE FEED FEET

PFAFF CL.461;481 DURKOPP CL.272 JUKI DLM-522

S518N-NF
(ART.1526/1)



S518-NF
(ART.1525/1)



SIZE -A
S518 -NF2.0mm
S518H -NF2.5mm
S518W -NF3.0mm
S518XW-NF3.5mm

140717-NF
(140717-0-01)
(503541)



MT1-NF
(ART.1602)



MT1-NFB →

NEEDLE FEED FEET

CF36LN-NF



CF36L-NF



CF36LW-NF



NEEDLE FEED ZIPPER FEET

CF363VNF



5mm

CF36N-NF



5mm

CF36-NF



8mm

CF36W-NF



10mm

NEEDLE FEED FEET

CF363-NF



5.4mm

CF363W-NF



7mm

CF58N-NF



8mm

CF58W-NF



9mm

NEEDLE FEED FEET

CF360-NF



8mm

CF361-NF



8mm

CF351-NF



11mm

CF127-NF



12.7mm

**PRESSER
FEET FOR
NECCHI
MACHINE**



**NEED FEED ADJUSTABLE CLOTH GUIDE
FOR NECCHI CL.881**

NH-10G

1. 可以調整左、右擋邊尺寸。
2. 車縫布條，可調整大小，0~20mm
1. Can Adjustable The Size of Both Side on The Edge.
2. Seam Cloth Can Adjustable The Tape Size. 0~20mm



**COMPENSATORY FOOT
FOR NECCHI CL.881**

NH8820

(LEFT)
NH8820 (ART.1626/1-1/32)
NH8821 (ART.1626/3-1/16)
NH8821N-1/16(NARROW)



NH36LN (ART.1647)

(RIGHT)
NH8810 (ART.1626/2-1/32)
NH8811 (ART.1626/4-1/16)
NH8811N-1/16(NARROW)
NH8812 (ART.1626/5-1/8)
NH8813 (ART.1626/6-3/16)
NH8814 (ART.1626/7-1/4)
NH8815 (ART.1626/8-5/16)
Nh8816 (ART.1626/9-3/8)



**PRESSER FEET
FOR NECCHI CL.881**

**NH36N
(ART.1648)**



**NH363
(ART.1646)**



**NH35
(ART.1551)
(961789-3-00)**



NH351



**PRESSER FEET
FOR NECCHI CL.881**

NH351W
(ART.1522)
(961761-3-00)



12.7mm

NH127



13mm

NH127W



14mm

**THE
PRODUCTS
INTRODUCE
AS BELOW**



ZIG-ZAG HINGED FOOT
BROTHER 651.652
SINGER 20U
PFAFF 483 etc.

Z-Z MACHINE ADJUSTABLE CLOTH GUIDE FEET

G10-652



1. 可以調整左、右擋邊尺寸。
2. 車縫布條，可調整大小，0~20mm
1. Can Adjustable The Size of Both Side on The Edge.
2. Seam Cloth Can Adjustable The Tape Size. 0~20mm

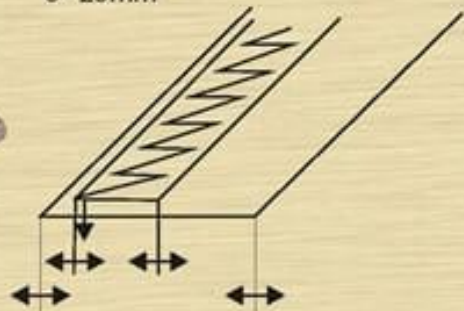

Z-Z ROLLER FEET

R-652

SIZE
R-652-6mm
R-652-12mm
(HM4-1)



Z-Z HEMMER FEET

652SH

SIZE
652SH-3mm
652SH-5mm



ZIG-ZAG FEET

652-35
(ART.1468)



3mm

55112B-G
(91-055112)



4.5mm

ZIG-ZAG FEET

54501
54501-G
(91-054501-03C)

230ZZ



ZIG-ZAG COMPENSATING FEET

652RZ
(ART.1699)

652LZ
(ART.1699/1)



ZIG-ZAG FOOT

55106-G
(91-055106CX-10)
(91-055106-23/006)

541566

541781

P603-Z5

NEW



ZIG-ZAG FOOT

MT541566

112800-0-01

111994-0-01

543939



說明如下
ACCOUNT
AS BELOW



PFAFF MACHINE ADJUSTABLE CLOTH GUIDE PFAFF CL.141.138.238

PF10G
(PF10G-CRL)

1. 可以調整左、右擋邊尺寸。
 2. 車縫布條，可調整大小，0~20mm
1. Can Adjustable The Size of Both Side on The Edge.
 2. Seam Cloth Can Adjustable The Tape Size. 0~20mm

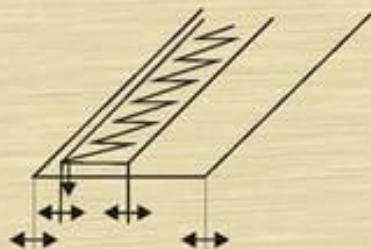

PFAFF FEET CL.141;138;238

611P



SIZE
610NP1/32
(NARROW)
611NP1/16
(NARROW)
611P1/16
612P1/8
613P3/16
614P1/4

621P



SIZE
620NP1/32
(NARROW)
621P1/16

630P
(DOUBLE)



SIZE
630P1/32
631P1/16

630ZZ
(91-0511863-93)



SIZE
630ZZ-3mm
630ZZ-5mm

PFAFF FEET CL.141;138;238

26473
(91-026473-05)



26474
(91-026474-05)



46682
(91-046682-03)



43522A
(91-043522-03)



PRESSER FEET FOR PFAFF CL.142;1242;921;925

54926-G 1/4

54926-G 3/16
(91-054926-03)
54926-G 1/4
(91-054926-03)
54926-G 9/32
(91-054926-03)



PF248

PF248(4.8mm)
30715-3-00
PF260(6.0mm)
961044-3-00
PF264(6.4mm)
961044-3-10



PFG248

PFG248(1.0mm)
(ART.1651/1-4.8mm-1.0mm)
PFG248(2.0mm)
(ART.1651/1-4.8mm-2.0mm)
PFG264(1.0mm)
(ART.1651/2-6.4mm-1.0mm)
PFG264(2.0mm)
(ART.1651/2-6.4mm-2.0mm)



PFR248

PFR248(4.8mm)
(ART.1628/1)
PFR264(6.4mm)
(ART.1628/2)



PRESSER FEET FOR PFAFF CL.142;1242;921;925

PFD248

PFD248(4.8mm)
ART.1639/1
PFD264(6.4mm)
ART.1639/2



COMPENSATING FEET FOR NECCHI CL.831

NH8320

(LEFT)
NH8320 (ART.1625/1 -1/32) (NARROW)
NH8321 (ART.1625/4 -1/16)
(RIGHT)
NH8310 (ART.1625/2 -1/32) (NARROW)
NH8311N-1/16 (NARROW)
NH8311 (ART.1625/5 -1/16)
NH8312 (ART.1625/6 -1/8)
NH8313 (ART.1625/7 -3/16)
NH8314 (ART.1625/8 -1/4)
NH8315 (ART.1625/9 -5/16)
NH8316 (ART.1625/10 -3/8)



HINGED FEET FOR NEEDLE FEED MACHINE CL.831

NH8331D-1/16

DOUBLE
NH8330D-1/32
(ART.1625/3-1/32)
NH8331D-1/16
(ART.1625/3-1/16)



NH363-1 (ART.1643)



NH36N-1 (ART.1642)



NH36LN-1 (ART.1641)



HINGED FEET FOR NEEDLE FEED MACHINE CL.831

CL831-NF1
(ART.1615)



底部
CL831-NFB 底部
(ART.1612/1)

NH36-1

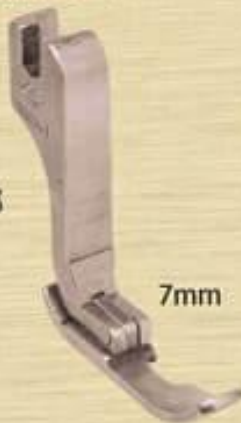

7mm

NH36L-1



7mm

PFAFF FEET CL.422

PF264-1



PF248-1
(ART.1694/1
4.8mm)
PF264-1
(ART.1694/2
6.4mm)

PRESSER FOOT FOR PFAFF CL.442

PFG264-2R



PFG248-1R(1.0mm)
(ART.1695/1 4.8mm)
PFG248-2R(2.0mm)
(ART.1695/2 4.8mm)
PFG264-1R(1.0mm)
(ART.1696/1 6.4mm)
PFG264-2R(2.0mm)
(ART.1696/2 6.4mm)

PFG264-2L



PFG248-1L(1.0mm)
(ART.1557/1 4.8mm)
PFG248-2L(2.0mm)
(ART.1557/2 4.8mm)
PFG264-1L(1.0mm)
(ART.1558/1 6.4mm)
PFG264-2L(2.0mm)
(ART.1558/2 6.4mm)

PRESSER FOOT FOR NECCHI CL.971;974;976

NH264N

NH248N
(ART.1698/1 4.8mm)
NH264N
(ART.1698/2 6.4mm)



NH264H

NH248H
(ART.6645/1 4.8mm)
NH264H
(ART.6645/2 6.4mm)
(HEAVY MATERIALS)



NH264

NH248
(ART.1623/1 4.8mm)
(961799-3-00)
NH260
(ART.1623/2 6.0mm)
(961773-3-00)
NH264
(ART.1623/3 6.4mm)
(961773-3-10)



NHG264H

NHG248H(2.0mm)
(ART.6646/1 4.8mm)
NHG264H(2.0mm)
(ART.6646/2 6.4mm)
(HEAVY MATERIALS)



PRESSER FOOT FOR NECCHI CL.971;974;976

NHG264-2R

NHG248-2R(2.0mm)
(ART.1652/1 4.8mm)
NHG264-2R(2.0mm)
(ART.1652/2 6.4mm)



NHR264

NHR248(2.0mm)
(ART.1627/1 4.8mm)
NHR264(2.0mm)
(ART.1627/2 6.4mm)



NHD264

NHD248(2.0mm)
(ART.1679/1 4.8mm)
NHD264(2.0mm)
(ART.1679/2 6.4mm)



**THE
PRODUCTS
INTRODUCE
AS BELOW**



ADJUSTABLE CLOTH GUIDE FOR DURKOPP MACHINE
DURKOPP CL.212

DK-10G



- 1. 可以調整左、右擋邊尺寸。
- 2. 車縫布條，可調整大小，0~20mm
- 1. Can Adjustable The Size of Both Side on The Edge.
- 2. Seam Cloth Can Adjustable The Tape Size. 0~20mm

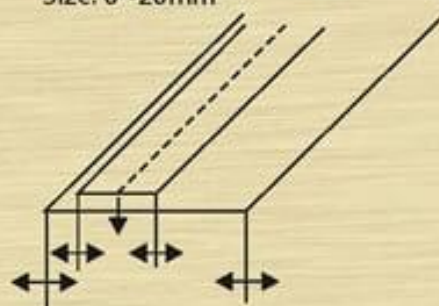

PRESSER FOOT FOR DURKOPP CL-212

DKMT-1
(ART.1603)



DKMT-1B
↓

DK36D
(ART.6647)



DOUBLE

PRESSER FOOT FOR DURKOPP CL-212

DK518N



2.0mm

DK518



SIZE -A
 DK518 -2.0mm
 DK518H -2.5mm
 DK518W -3.0mm
 DK518XW -3.5mm

A 2.0mm

DK363
 (ART.1623)



5.4mm

DK363W
 (ART.1685)



7mm

PRESSER FOOT FOR DURKOPP CL-212

DK36N
 (ART.1682)



5.4mm

DK36
 (ART.1687)



8mm

DK36LN
 (ART.1681)

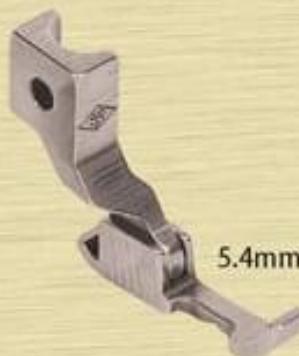

5.4mm

DK36L
 (ART.1686)

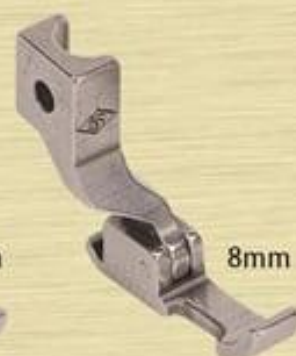

8mm

PRESSER FEET FOR DURKOPP CL-212

DK211



DK21R (ART.1620/2 -1/32)
 DK211 (ART.1620/4 -1/16)
 DK212 (ART.1620/6 -1/8)
 DK213 (ART.1620/8 -3/16)
 DK214 (ART.1620/10-1/4)
 DK215 (ART.1620/12-5/16)
 DK216 (ART.1620/14-3/8)
 DK218 (ART.1620/16-1/2)

DK221



DK22L (ART.1620/1 -1/32)
 DK221 (ART.1620/3 -1/16)
 DK222 (ART.1620/5 -1/8)
 DK223 (ART.1620/7 -3/16)
 DK224 (ART.1620/9 -1/4)
 DK225 (ART.1620/11-5/16)
 DK226 (ART.1620/13-3/8)
 DK228 (ART.1620/15-1/2)

PRESSER FEET FOR DURKOPP CL-212

DK351
(212-1193)
(ART.1309)



7/16

DK127
(212-903)
(ART.6650)



33/64

PRESSER FEET FOR DURKOPP CL-212

DK127W
(212-1643)
(ART.1289)



35/64

DK127WK
(212-887)
(ART.1285)



35/64

DURKOPP W/GUIDE HINGED FEET CL.212

DK-821-1/16



DK-820-1/32
DK-821-1/16
DK-822-1/8
DK-823-3/16
DK-824-1/4
DK-825-5/16

DK-811-1/16



DK-810-1/32
DK-811-1/16
DK-812-1/8
DK-813-3/16
DK-814-1/4
DK-815-5/16

HINGED BRASSIERE FEET WITH GUIDE

CF570H
1/4-2.6L

NEW

CF570H
1/4-2.6R

NEW



HEAVY



HEAVY

ZIG-ZAG MACHINE EGDE GUIDE ADJUSTABLE FEET

G10-457



1. 可以調整左、右擋邊尺寸。
2. 車縫布條，可調整大小，0~20mm
1. Can Adjustable The Size of Both Side on The Edge.
2. Seam Cloth Can Adjustable The Tape Size. 0~20mm

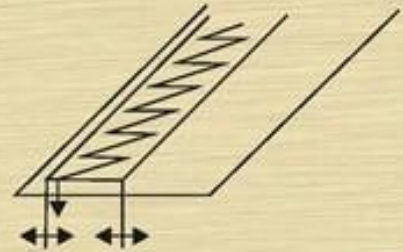

DOUBLE NEEDLE ADJUSTABLE EXTRA CLOTH GUIDE FEET

107-A25



5mm~50mm

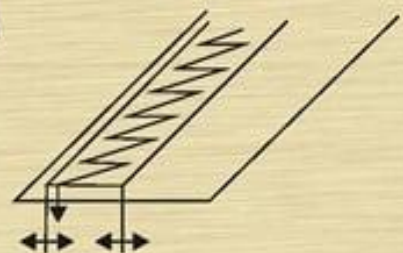

**ZIG-ZAG ADJUSTABLE FOOT WITH GUIDE
SINGER 457G; 457U ;107W**

S457ATS
(23781)

NEW



車縫布條，可調整大小
SEAM CLOTH CAN
ADJUSTABLE THE
TAPE SIZE
5mm~20mm

細條尺寸 Tape Size: 5mm~17mm ← Adj Guide
可調節底層布料的位置

The position of lower layer can be adjusted.

**ZIG-ZAG ADJUSTABLE FOOT
SINGER 457G; 457U; 107W**

S457AT
(503896)

S457AT-G
(503896-G)



車縫布條，可調整大小
SEAM CLOTH CAN
ADJUSTABLE THE
TAPE SIZE
5mm~20mm

**ZIG-ZAG REMOVE FEET
SINGER 457G; 457U; 107W**

107GK



Needle size-Outer Width
12mm-19mm

可以調整左、右擋邊尺寸
CAN ADJUSTABLE THE SIZE OF
BOTH SIDE ON THE EGDE

ZIG-ZAG ELASTIC FEET

107CA
(23771S)



107CA-6mm
107CA-8mm
107CA-10mm
107CA-12mm

ZIG-ZAG ROLLER FOOT

R-457-1
(HM4-5)



(針孔寬 - 外徑寬)
NEEDLE SIZE - OUTER WIDTH
R-457-1 7.5 -17.5(HM4-5)
R-457-2 10.5 -20.5(HM4-7)
R-457-3 12.5 -22.5
R-457-4 14.5 -23.5(HM4-3)

ZIG-ZAG TEFLON COATED FEET

CF457-2



(針孔寬 - 外徑寬)
NEEDLE SIZE - OUTER WIDTH
CF457-1 5.0 -10
CF457-2 7.5 -12
CF457-3 7.5 -14
CF457-4 10.5 -16
CF457-5 12.5 -19
CF457-6 14.5 -22.5

ZIG-ZAG PRESSER FOOT For 107W;457G;457U etc.

411314



503660



503736



THE THREAD ENTER
THE GROOVE ON
THE FRONT SECTION

411314-1

(NEEDLE HOLE WIDTH)
411314-1 6.5mm
411314-2 7.5mm
411314-3 10.5mm
411314-4 12.5mm
411314-5 14.5mm



ZIG-ZAG PRESSER FOOT For 107W;457G;457U etc.

23705
(266125)



241414



107CR



107CL



COMPENSATING FEET For 107W;457G;457U

PF-A1R



RIGHT

PF-A1L



LEFT

521ZR



521ZL



ZIG-ZAG HEMMER FOOT

457SH



HINGED FEET FOR ZIG-ZAG MACHINE
(SINGER 111W,211W)

P375
(241375)



P375BL



P882
(229882)



ZIG-ZAG EDGE GUIDE FEET For 107W;457G;457U

107SGR-2



107SGL-2



ZIG-ZAG EDGE GUIDE FEET For 107W;457G;457U

107SGR-4



107SGL-4



ZIG-ZAG BINDER FEET

107-6L

NEW

210562A2

210564A4



ZIG-ZAG BRASSIERE FOOT

457-02 適用直線 (LONG BOTTOM)

457-2 適用轉角 (SHORT BOTTOM)



	外寬	- 針孔寬
	OUTER WIDTH	- NEEDLESIZE
457-01	(10.2mm)	- 6.2mm)
457-02	(12 mm)	- 7.5mm)
457-03	(14 mm)	- 7.5mm)
457-04	(16 mm)	- 10.5mm)
457-05	(19 mm)	- 12.5mm)
457-06	(22 mm)	- 14.5mm)



	外寬	- 針孔寬
	OUTER WIDTH	- NEEDLESIZE
457-1	(10.2mm)	- 6.2mm)
457-2	(12 mm)	- 7.5mm)
457-3	(14 mm)	- 7.5mm)
457-4	(16 mm)	- 10.5mm)
457-5	(19 mm)	- 12.5mm)
457-6	(22 mm)	- 14.5mm)

INVISIBLE CUTTER THREAD FEET

282140

282139



ZIG-ZAG THICKER MATERIAL FEET

503595
503595-G



厚物 (HEAVY)

ZIG-ZAG LIGHT MATERIAL FEET

503595HK
503595HK-G



薄物 (LIGHT)

ZIG-ZAG THICKER MATERIAL FEET

503689
503689-G



厚物 (HEAVY)

ZIG-ZAG LIGHT MATERIAL FEET

503689HK
503689HK-G



薄物 (LIGHT)

ZIG-ZAG STANDARD FEET

411215
411215-G



標準押布腳
STANDARD FEET

ZIG-ZAG STANDARD FEET

503818
503818-G



標準押布腳
STANDARD FEET

SINGLE NEEDLE FOR ALL MACHINE

150384-0-01

可加裝在各廠牌單針安全保護套
THE SAFETY GUARD USE ON ALL
KIND OF MACHINE FOR SINGLE
NEEDLE.

150384-0-01 →



FOR SINGER SINGLE NEEDLE MACHINES

#5G

Classes:95;96;400W;
600w;31-15;241;251
ETC.
NEEDLE GUARD



**FOR BROTHER JUKI
NECCHI PFAFF SINGER**

#19S

NEEDLE GUARD
(#61231A)



**FOR SINGER Classes:
112W;212W;ETC.**

#14R
NEEDLE GUARD



**FOR SINGER Classes:
SINGLE NEEDLE MACHINE
107W;111W;143W;153K;
153W;457G;ETC.**

#259081
NEEDLE GUARD
(#225365)



FOR WW DOUBLE NEEDLE MACHINES

#22G
NEEDLE GUARD



**FOR SINGER Classes:
SINGLE NEEDLE MACHINE
108W,111W,211G,211W, AND WW**

#16A
NEEDLE GUARD
(#490607)



TURRET TO TAKE 3 PRESSER FEET

154628-0-01
(FOR BROTHER)



MAS-07300-AA0
(FOR JUKI)

#SS1
#PB-3
#NBBF



PRESSER FOOT NOT INCLUDED
僅提示其功能不包括押布腳

YIH  **SHIN**

SINCE 1975

邑新針車企業有限公司

YIH SHIN SEWING MACHINE CO., LTD

TAIPEI · TAIWAN



TEL:+886-2-2995-5127

FAX:+886-2-2995-5871

URL:www.yihshin.com

EMAIL:ys5127@livemail.tw